

CREATE
YOUR STYLE with
CRYSTALLIZED™
- Swarovski Elements



WEDDING PRINCESS NAPKIN RING



WEDDING PRINCESS NAPKIN RING



CRYSTALLIZED™ – Swarovski Elements

Article	Product Group	Article No.	Amount	Size	Colour	Colour Code
	Beads	5000	12 pcs.	3 mm	Jet	280
	Beads	5020	6 pcs.	8 mm	Crystal AB	001 AB
	Beads	5301	12 pcs.	4 mm	Crystal Moonlight	001 MOL

Supplies & Tools

Supplies
 2.5 cm x 52 cm satin ribbon cream
 312 cm nylon thread 0.15 mm transparent

Tools
 tissue paper
 pencil
 sewing needle
 scissors
 fixing pins
 sewing thread
 ruler

STEP 1

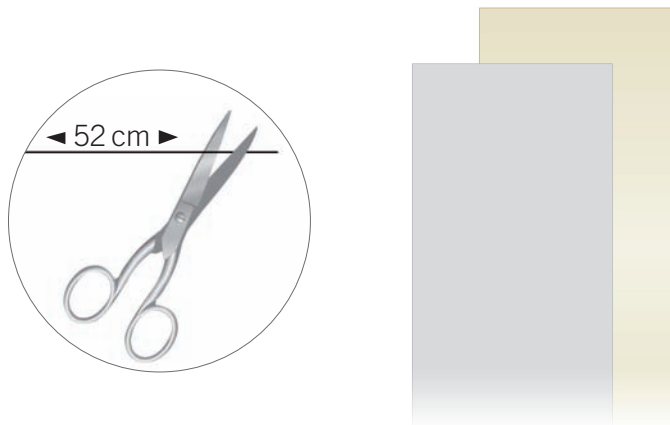

STEP 2

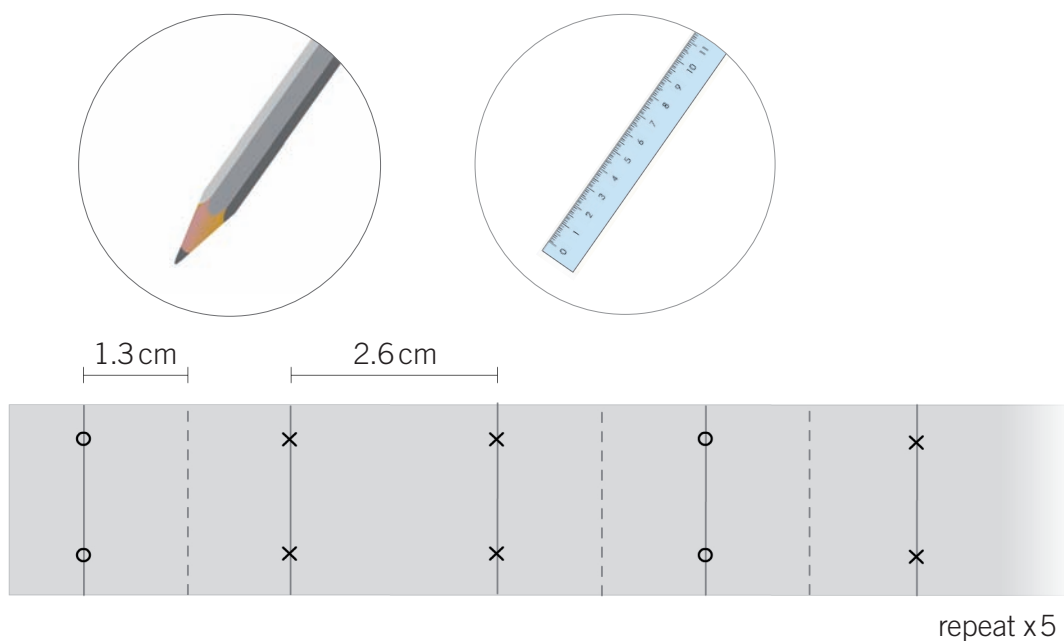

STEP 3

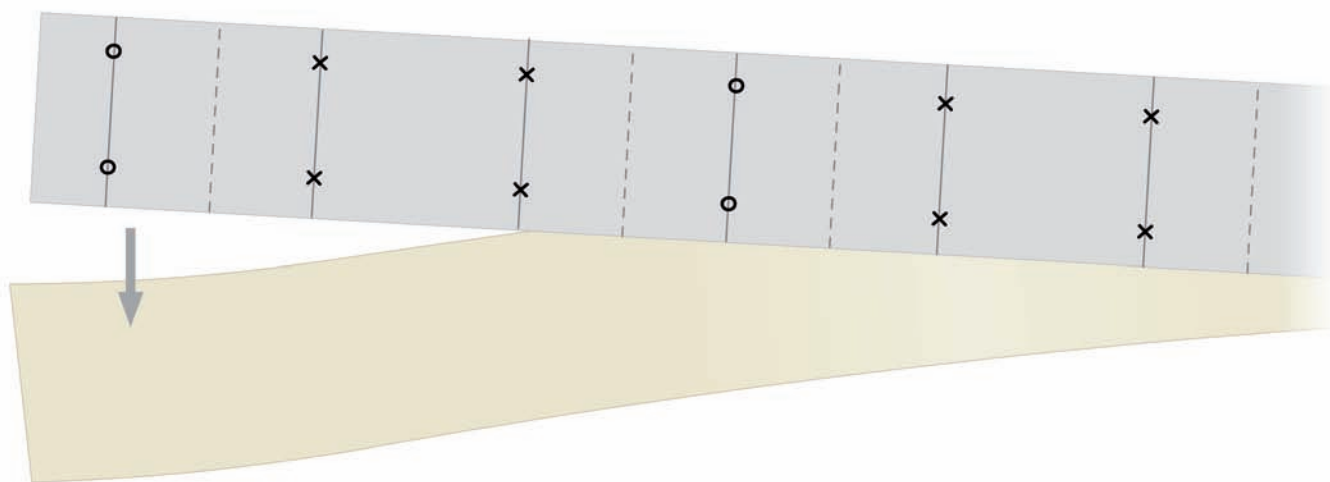

STEP 4

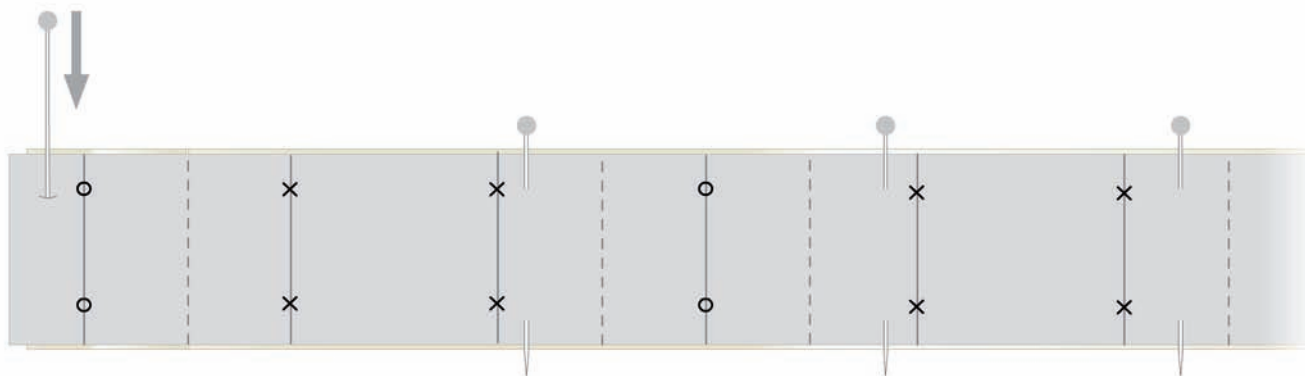

STEP 5

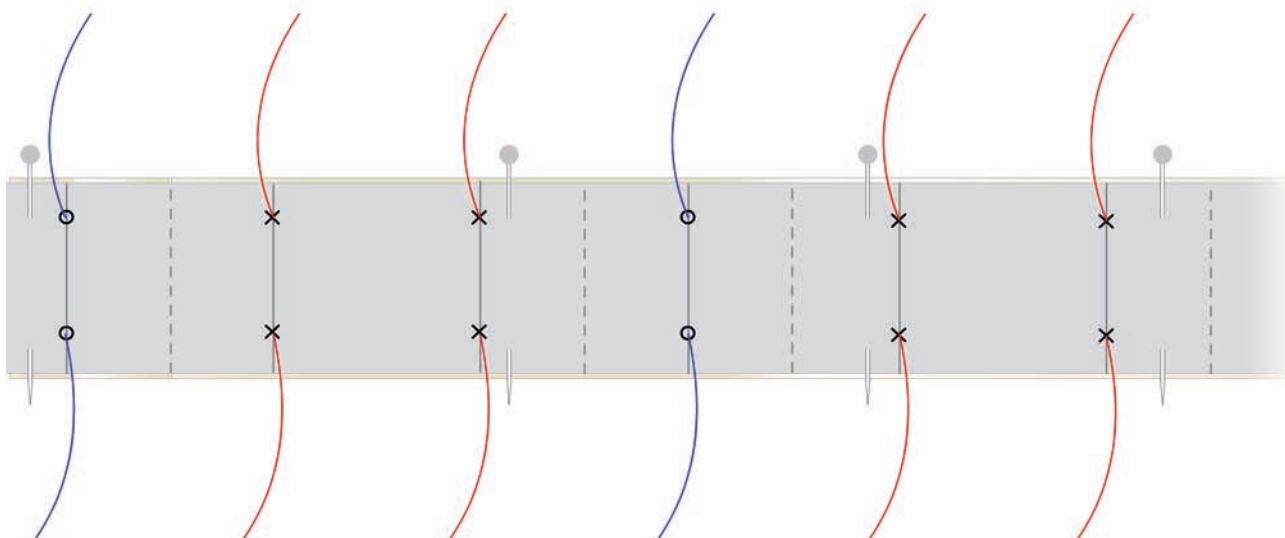
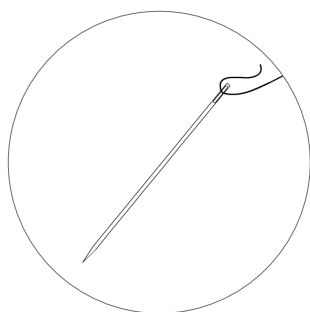

STEP 6

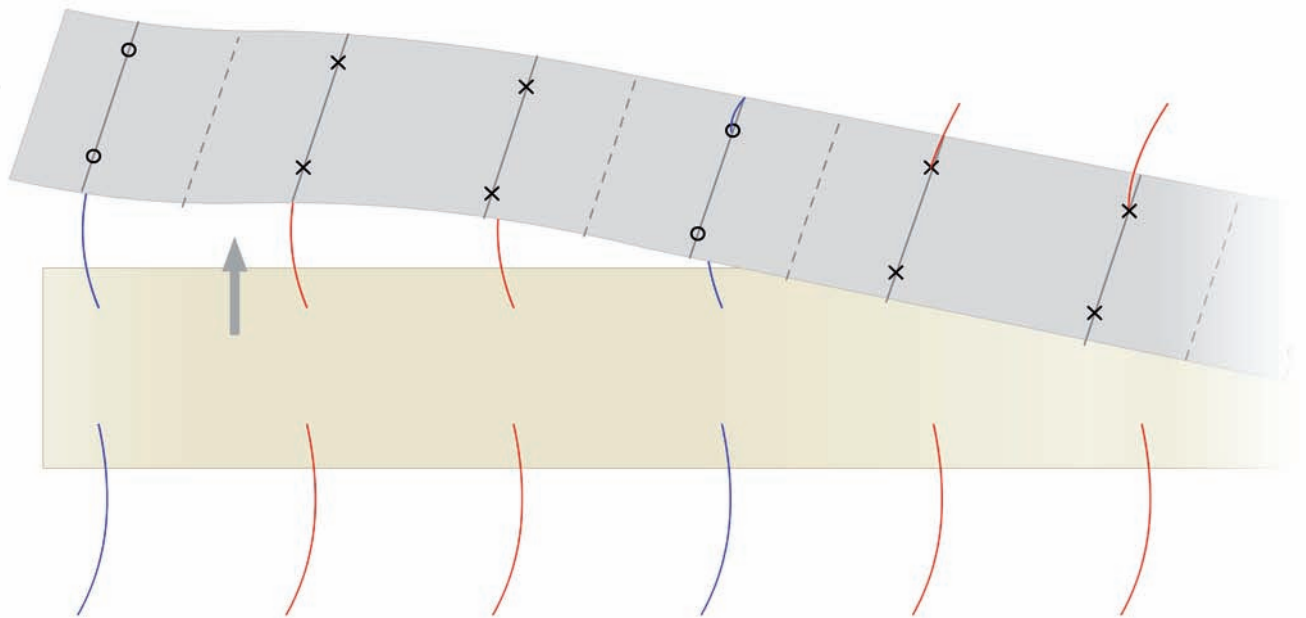

STEP 7

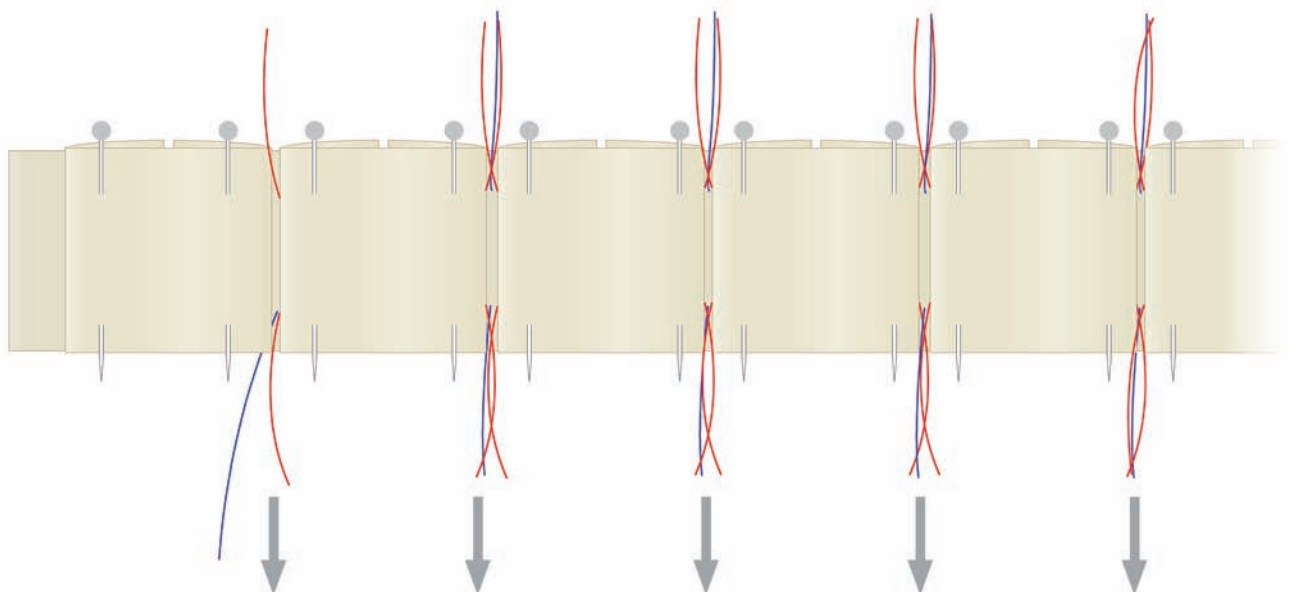
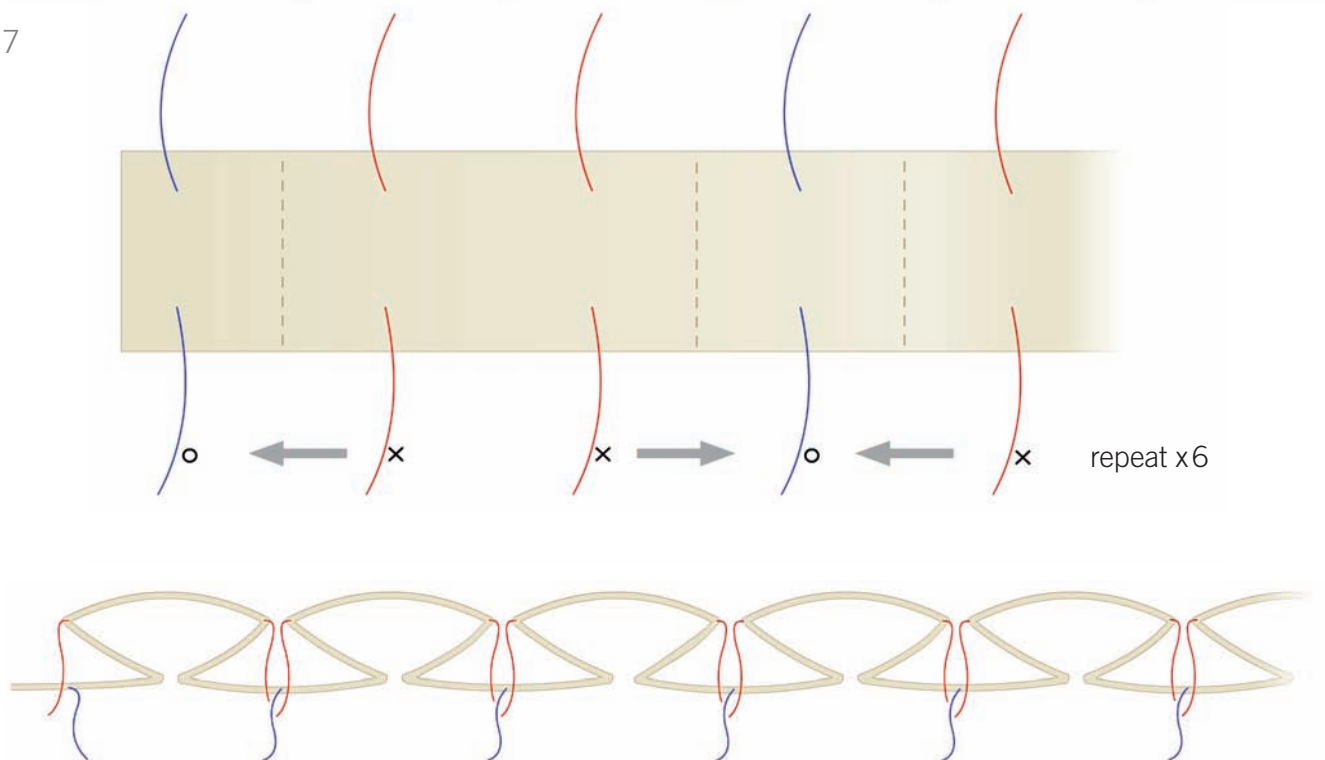

STEP 8

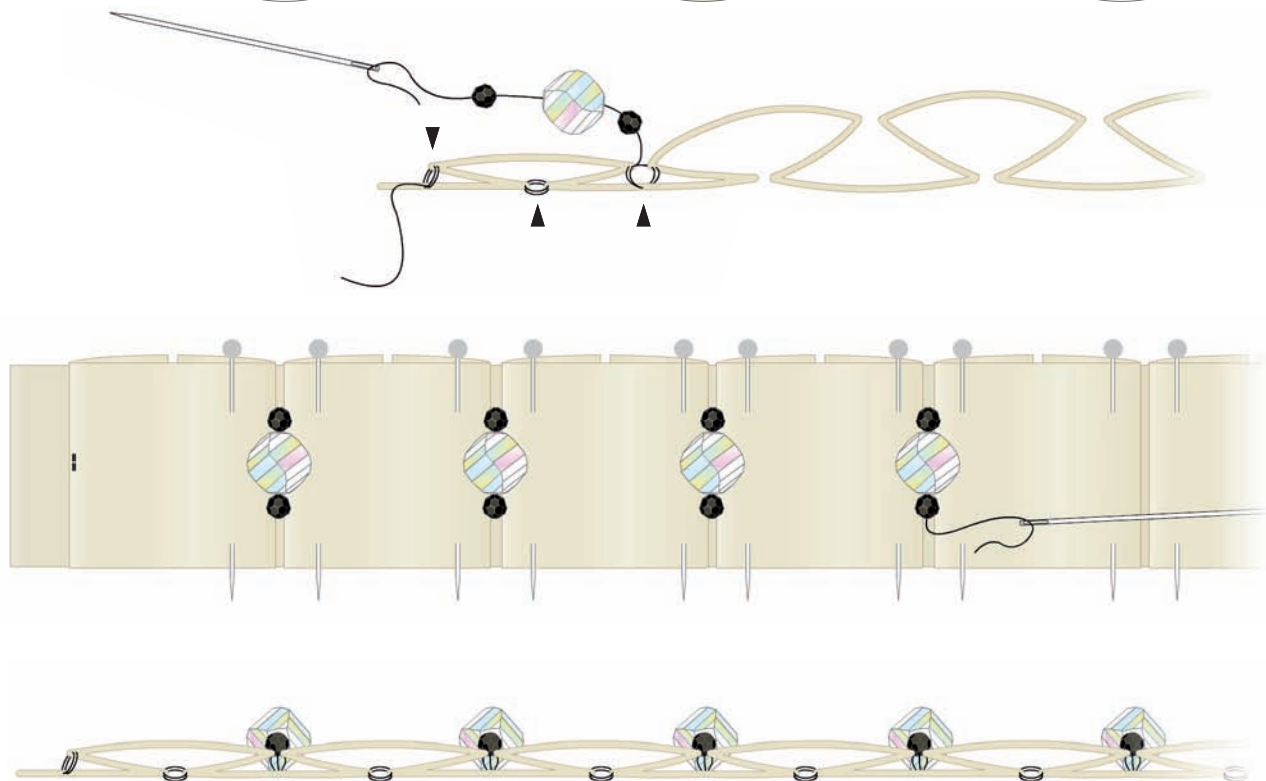
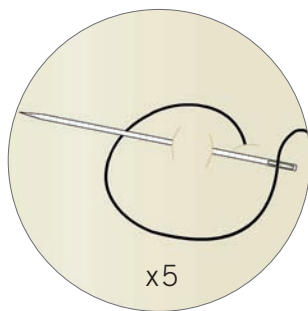
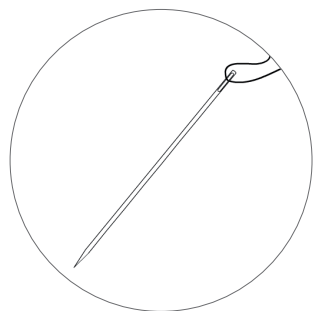

STEP 9

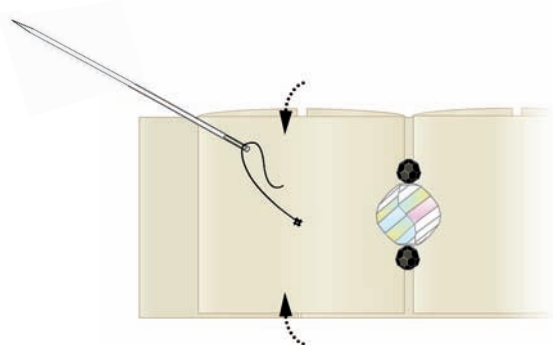
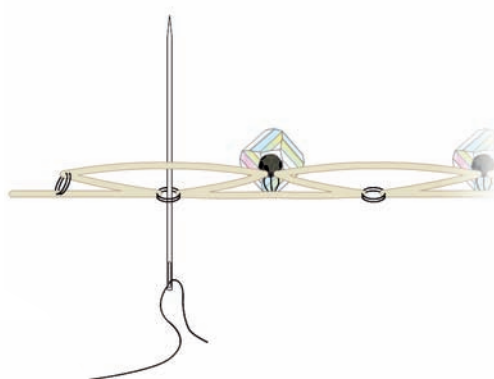
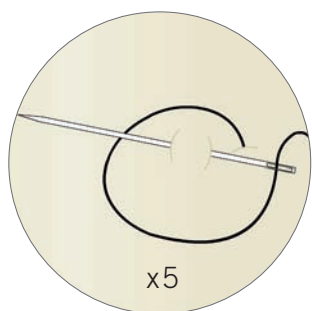

STEP 10

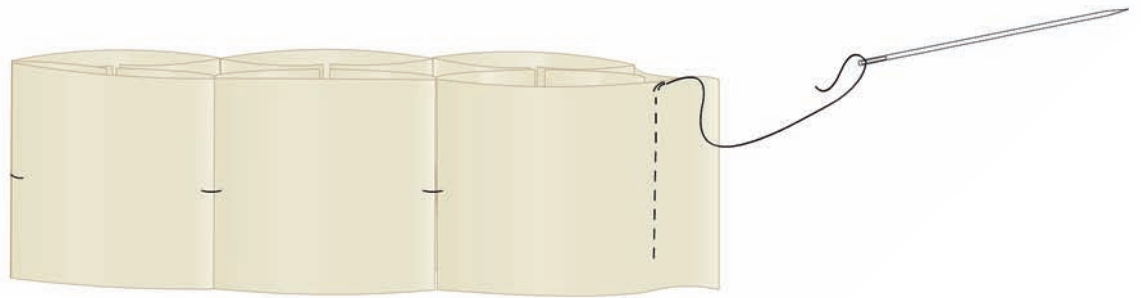
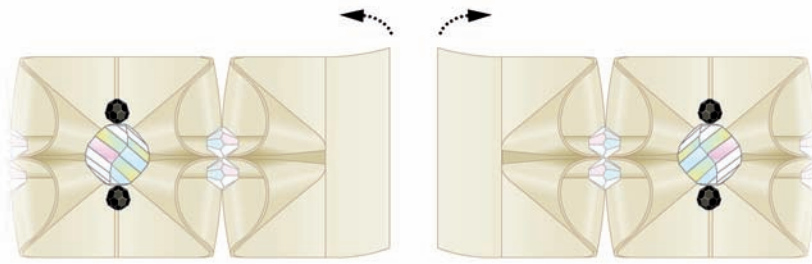

STEP 11

