

CREATE
YOUR STYLE with
CRYSTALLIZED™
- Swarovski Elements

WEDDING COUNTRY NAPKIN RING

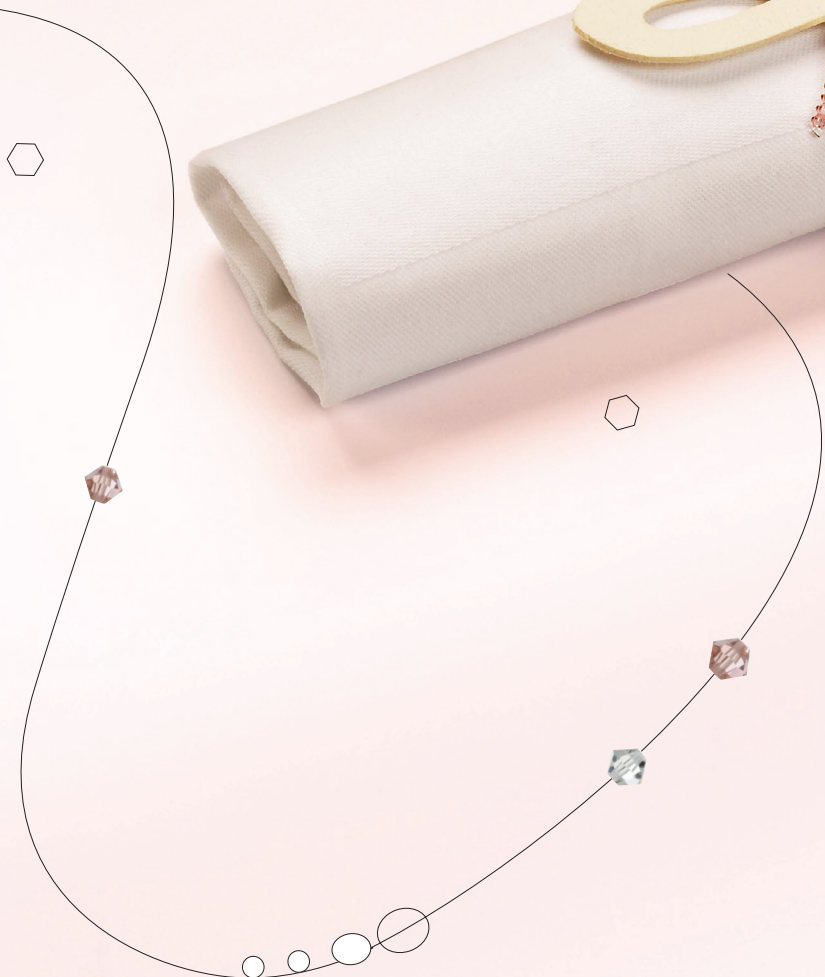

WEDDING COUNTRY NAPKIN RING



CRYSTALLIZED™ – Swarovski Elements

Article	Product Group	Article No.	Amount	Size	Colour	Colour Code
	Sew-on Stones	3128	1 pc.	8 mm	Crystal	001
	Beads	5301	42 pcs.	4 mm	Vintage Rose AB	319 AB
	Beads	5301	36 pcs.	3 mm	Vintage Rose	319

Supplies & Tools

Supplies

- 75 cm nylon thread 0.25 mm
- 6 pcs. crimp beads 2 mm silver
- 30x12 cm suede (or felt) 1 mm cream white
- 30x12 cm card board 0.6 mm

Tools

- cutter
- needle
- eraser
- pencil
- scissors

STEP 1

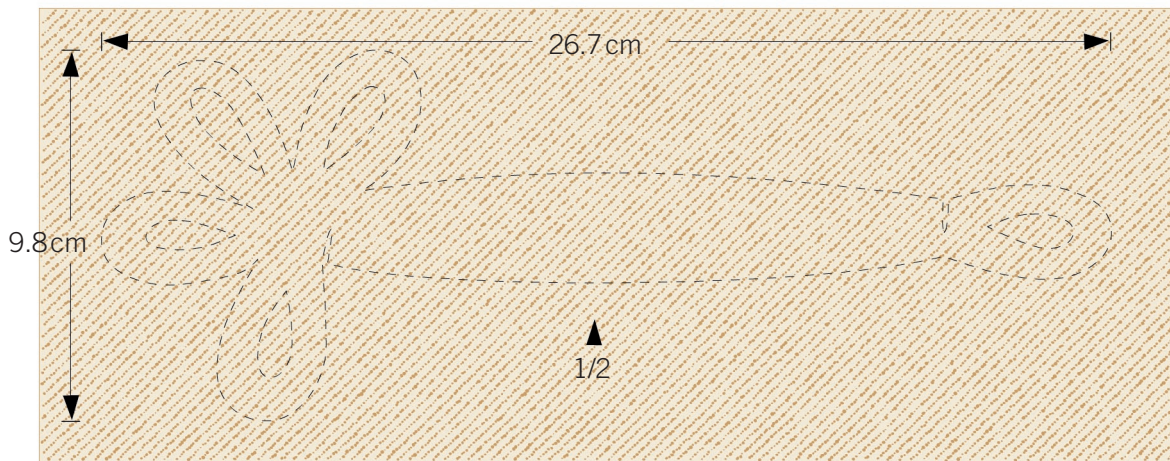

scale 1:2

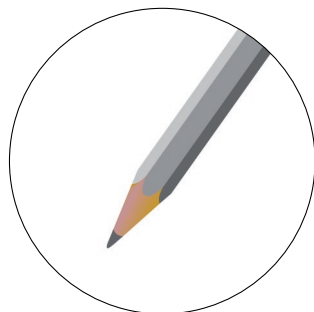

1



2

STEP 2

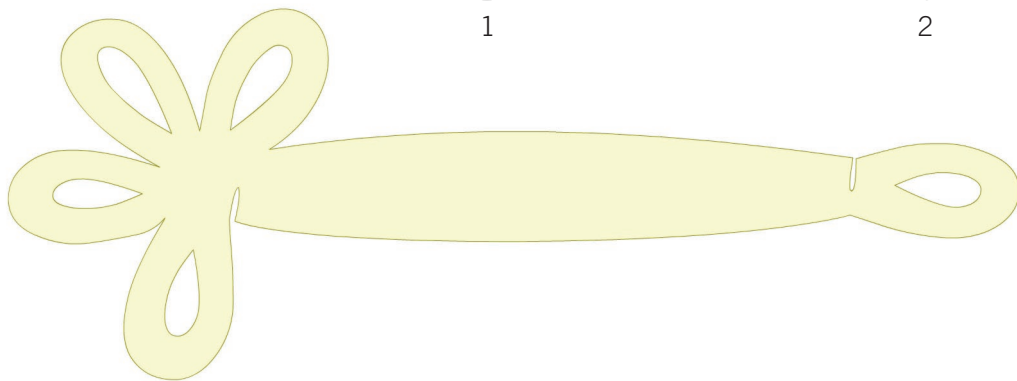
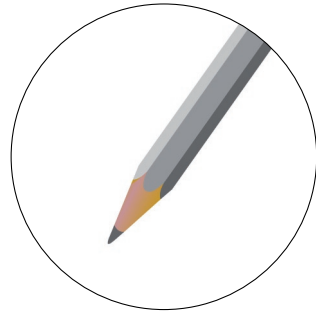
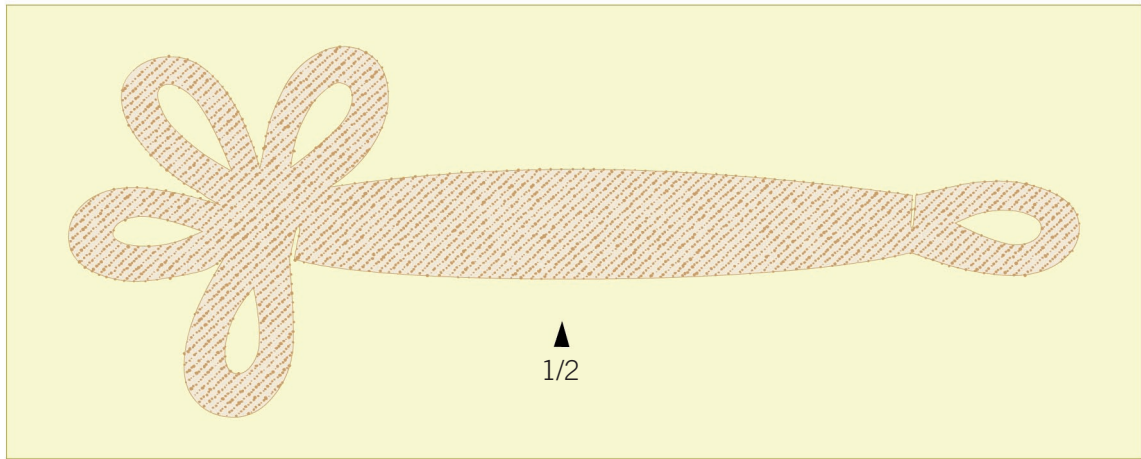

STEP 3

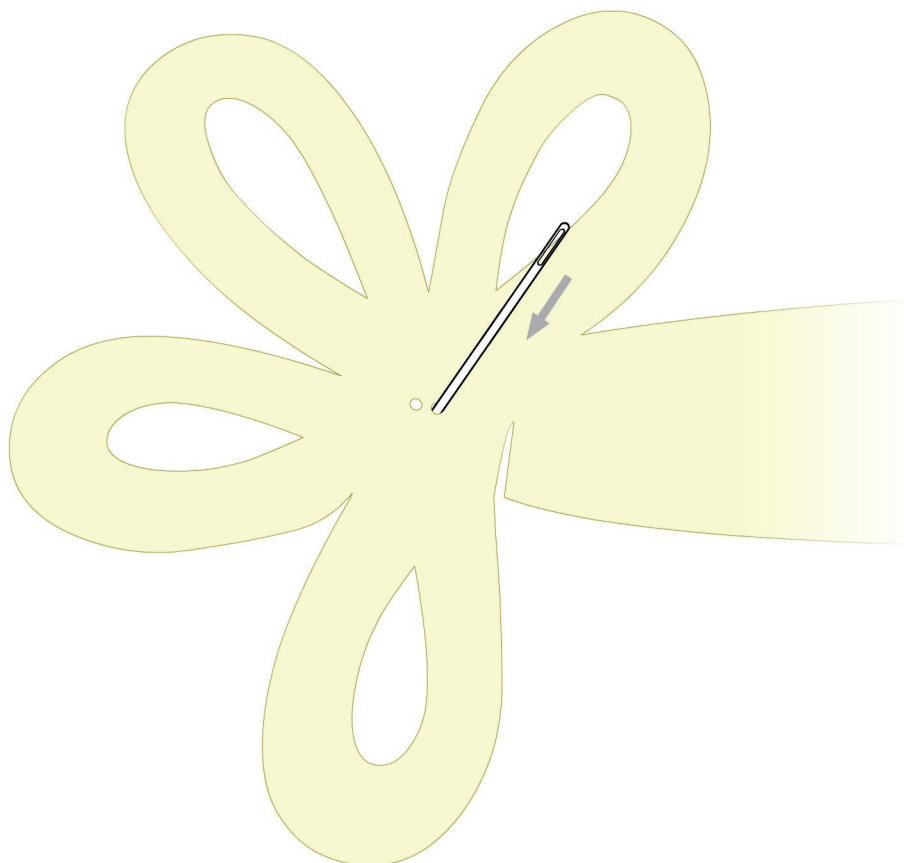

STEP 4

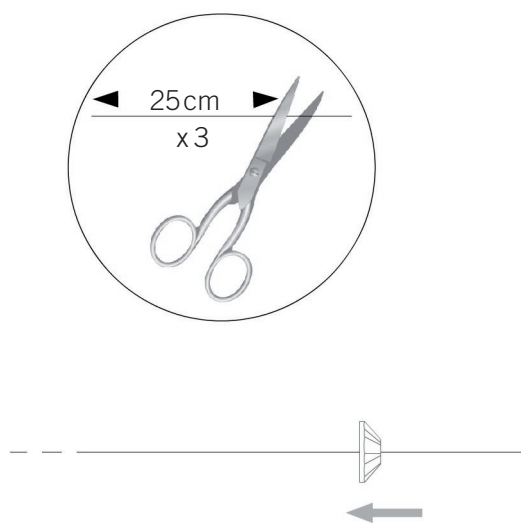

STEP 5

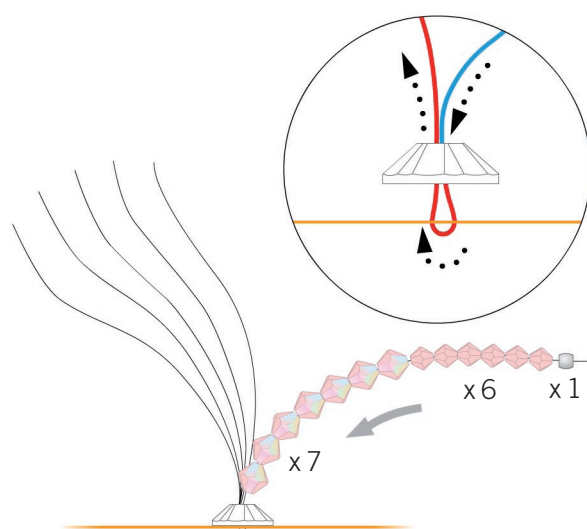

STEP 6

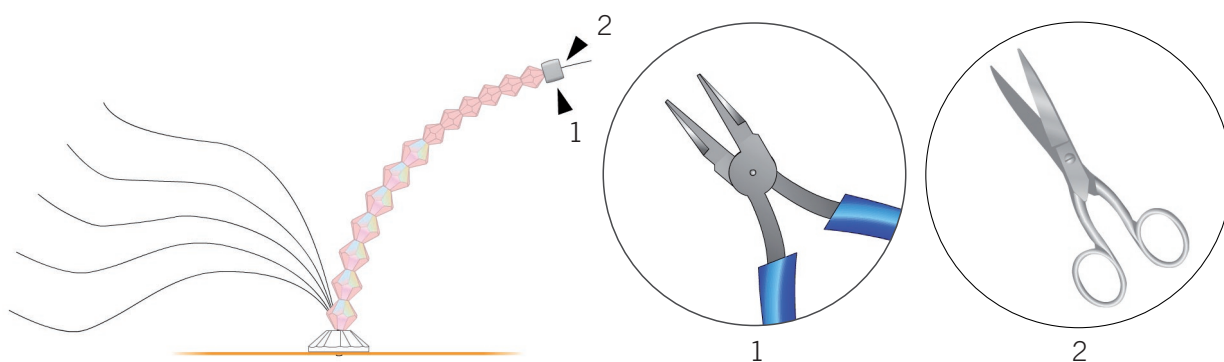

repeat steps 5 – 6 x 5

STEP 7

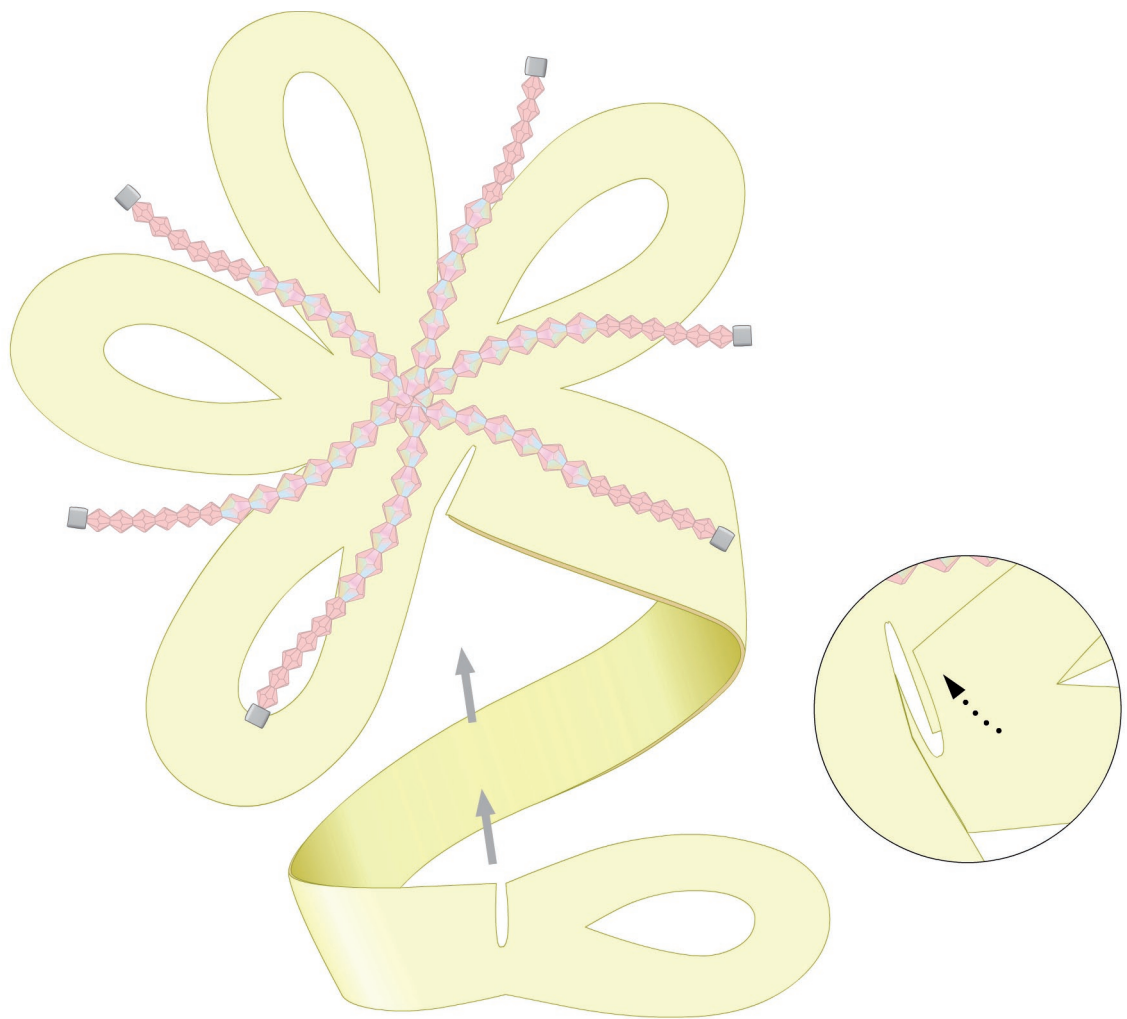

STEP 8

